

FALLROHRSCHELLE MIT SCHLAGSTIFT 200 MM

Art.-Nr.:	50264
Nenngröße [mm]:	76
Material:	Stahl verzinkt

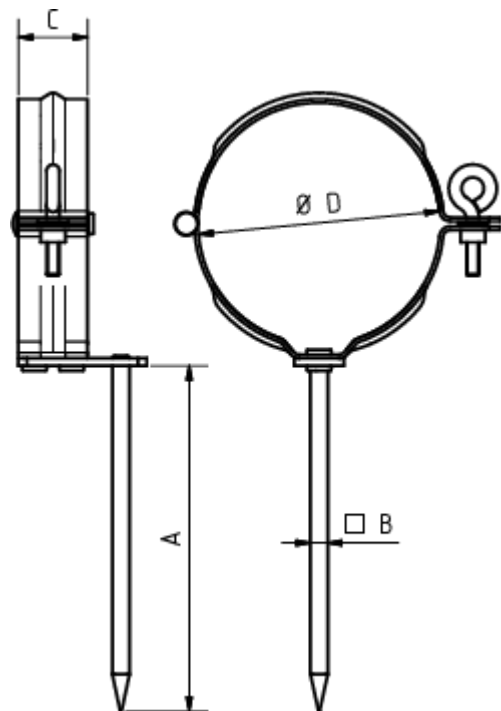

Maße [mm]:

A	B	C	D
200	7	28	74