

FALLROHRSCHELLE MIT SCHLAGSTIFT 200 MM

Art.-Nr.: 50266
Nenngröße [mm]: 87
Material: Stahl verzinkt

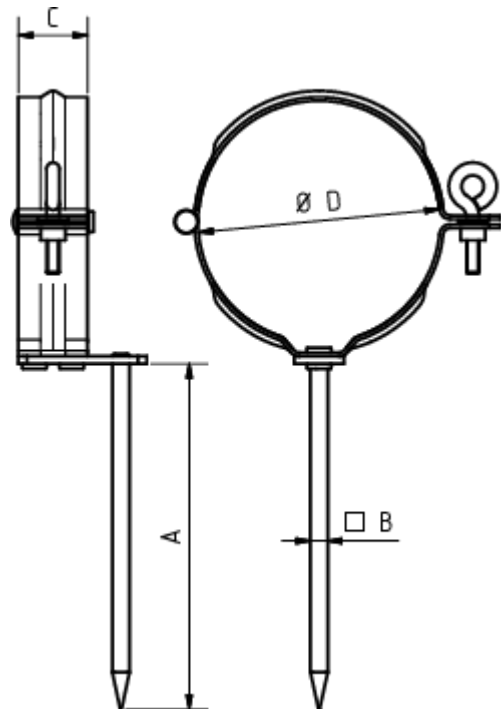

Maße [mm]:

A	B	C	D
200	7	28	85